



CASING SPACERS & INSULATORS



ADVANCE
PRODUCTS & SYSTEMS, LLC

Casing Spacers with ApogeeAero® Rollers
-see page 7



Casing Spacers with field changeable risers/runners
-see page 5

ISO 9001:2015 CERTIFIED COMPANY - FM537405
WWW.APSONLINE.COM

CASING SPACERS & INSULATORS FOR CENTERING OR CUSTOM POSITIONING WITHIN CASING



APS CASING SPACERS & INSULATORS

VS

SKIDS & STRAPS

Easy and efficient to install requiring no grease and no special tools

Difficult to install, cumbersome, time consuming and hard to secure accurately

Installation by one person

Requires several workers and extended time to position

Slides into place with ease
Coefficient of friction = .1

Very resistant to sliding often damaging skids enough to need replacement before installation is complete

Requires no backfill

Requires backfill, such as sand, pea gravel or grout

Decades of proven reliability

High failure rate

Insulating and long-term corrosion protection

Non-insulating and allows bacteria and differential oxygen concentration corrosion

***APS Casing Spacers are designed for straight casing applications. For any casing that involves a change in angle or direction (curved, bent, or considerable misalignment), please consult APS.

ADVANCE... THE DEPENDABILITY OF YOUR PIPELINES



Advance Products & Systems' Casing Spacers and Insulators combine proven dependability and ease of installation to outperform the labor intensive, inefficient and unreliable wooden skids. APS Casing Spacers and Insulators are your answer to lower installation costs with continued access for maintenance.

Casing Spacers are used to center water, sewer, gas and other fluids in casings. Casing insulators are used to support and electrically insulate a cathodically protected pipeline from a casing pipe through which it must pass. APS provides each in a number of common sizes as well as end seals to accommodate any combination of pipe sizes. These products are virtually corrosion proof and provide insulating protection from a possible electrical shorting between the carrier pipe and casing.

APS has the experience to manufacture almost any configuration required from multiple carrier product lines within a single casing to concentrically fitting a bell and spigot ductile iron pipe within its casing. APS has quality personnel to respond to your individual needs.

FOR CENTERING OR CUSTOM POSITIONING WITHIN CASING

APS Casing Spacers require no special tools, no grease, and they are easily bolted on by a single worker. They eliminate the need to fill the casing annulus with sand, grout or pea gravel which all act as electrolytes and can introduce unwanted current to the steel or ductile iron. Abrasion resistant dielectric runners prevent damage as the carrier pipe is being installed in the casing and, along with the dielectric inner liner, provide optimum insulation.

APS offers three types of spacers and insulators:

- Stainless Steel Band (Model SSI)
- Carbon Steel (Model SI)
- Polyethylene (Model CI).



MODEL CI



MODEL SSI

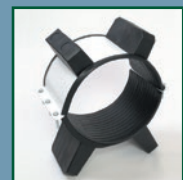

MODEL SI

STAINLESS STEEL BAND CASING SPACERS MODEL SSI

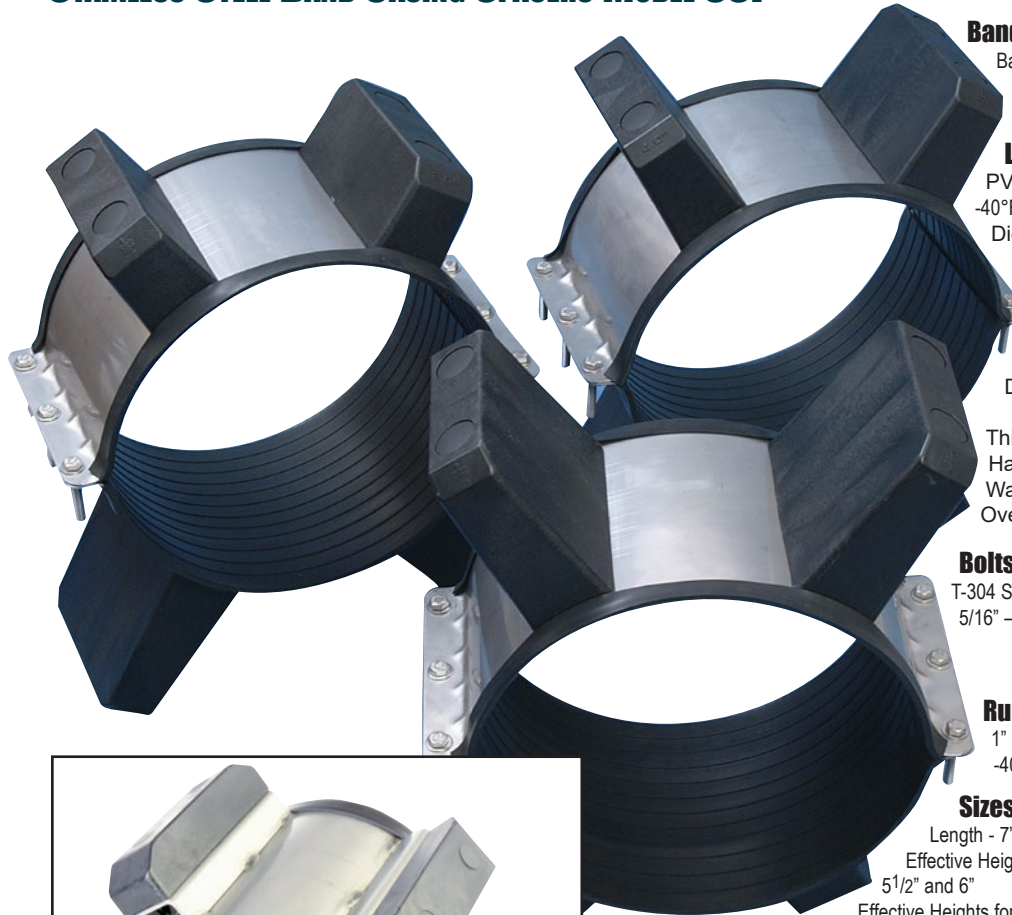

Band and Risers

Band - 14 Gauge, T-304 Stainless Steel
 Width: 8" & 12"
 Riser - 10 Gauge T-304 Stainless Steel

Liner

PVC
 -40°F to +140°F
 Dielectric Strength - {1/8" (3.18 mm) thick}
 60,000 V min.
 Thickness - .090" +/- .010"
 Hardness - 80 Duro +/- 5
 EPDM
 -40°F to +250°F
 Dielectric Strength - {1/8" (3.18 mm) thick}
 50,000 V min.
 Thickness - .090" (2.29mm) min.
 Hardness - Durometer "A" 85-90
 Water Absorption - 1% max.
 Overlaps Edges

Bolts, Nuts and Washers

T-304 Stainless Steel –
 5/16" – 18UNC x 2" long bolts
 5/16" hex nuts
 5/16" washers

Runners/risers

1" or 2" wide glass filled polymer plastic
 -40°F to +180°F

Sizes of Runners/risers available:

Length - 7" & 11" (17.8, 27.9 cm)
 Effective Heights for 7" Length - 1", 1 1/2", 2", 2 1/2", 3", 3 1/2", 4", 4 1/2", 5", 5 1/2" and 6"
 Effective Heights for 11" Length - 1", 1 1/2"



Runner Material Specifications:

Rockwell Hardness (M) - (ASTM D785) - 101
 Tensile Strength - (ASTM D638) - 27,000 psi
 Flexural Strength - (ASTM D790) - 38,000 psi
 Deflection Temp. @ 264 psi - (ASTM D648) - 480 °F (249 °C)
 Deformation Under Load @ 72 °F (22 °C) - 3500 lb.
 Load, - (ASTM D648) - 1%

Welding

All risers are welded to the band by MIG welding.
 Stainless steel welds are fully passivated.

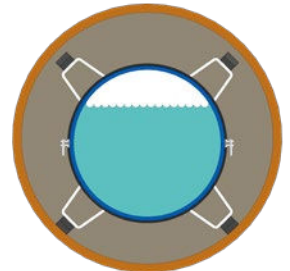

Equal Legs

STAINLESS STEEL BAND SPACERS & INSULATORS (MODEL SSI)

Heavy duty two-piece stainless steel bands serve practically every piping application and should be utilized inside casing that is 2 or 3 sizes larger than the carrier pipe.

APS stainless steel band casing spacers are available in two models: the SSI8 model, which is 8" in width and recommended for carrier pipe 4" to 36"; and the SSI12 model, which is 12" in width and is recommended for pipe above 36" to 120" and larger. Stainless steel band spacers are recommended for every 6 to 8 feet of pipeline, depending on pipe type.

For larger diameter pipelines and bell and spigot applications, APS spacers are available with runners/risers to provide an extra margin of safety. The bands are constructed of 14 gauge stainless steel with a standard 0.090" PVC or EPDM liner. Stainless steel spacers are available in grade 304.

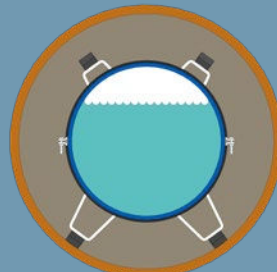

Centered



Clear Bell

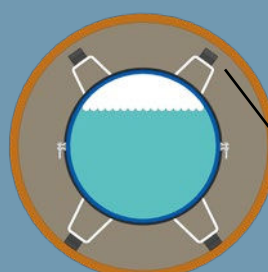

Centered & Restrained

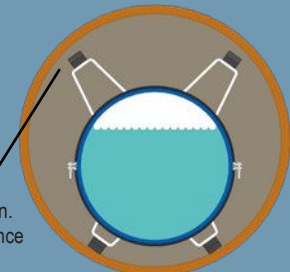

Non-Centered, Restrained

1" min.
 clearance

STEEL BAND CASING SPACERS MODEL SI

Band and Risers

Band - 14 Gauge, hot rolled, pickled & oiled steel
Width: 8" & 12"
Riser - 10 Gauge, hot rolled, pickled & oiled steel

Liner

PVC

-40°F to +140°F
Dielectric Strength -
{1/8" (3.18 mm) thick}
60,000 V min.
Thickness - .090" +/- .010"
Hardness - 80 Duro +/- 5

EPDM

-40°F to +250°F
Dielectric Strength -
{1/8" (3.18 mm) thick}
50,000 V min.
Thickness - .090" (2.29mm) min.
Hardness - Durometer "A" 85-90
Water Absorption - 1% max.
Overlaps Edges

Bolts, Nuts and Washers

Electro Plated - 5/16" - 18" X 2" bolts,
5/16" hex nuts
5/16" washers SAE 2330

Runners/risers

1" or 2" wide glass filled polymer plastic
-40°F to +180°F

Sizes of Runners/risers available:

Length - 7" & 11" (17.8, 27.9 cm)
Effective Heights for 7" Length - 1", 1 1/2", 2", 2 1/2",
3", 3 1/2", 4", 4 1/2", 5", 5 1/2" and 6"
Effective Heights for 11" Length - 1", 1 1/2"

Runner Material Specifications:

Rockwell Hardness (M) - (ASTM D785) - 101
Tensile Strength - (ASTM D638) - 27,000 psi
Flexural Strength - (ASTM D790) - 38,000 psi
Deflection Temp. @ 264 psi - (ASTM D648) - 480 °F (249 °C)
Deformation Under Load @ 72 °F (22 °C) - 3500 lb.
Load, - (ASTM D648) - 1%

Finish

Thermoplastic Powder Coating Specifications
Durometer - Shore A2 (10 Sec.)
(ASTM D1706-61T) - 50-55
Max. Temperature - 150 °F (65 °C)
Electrical Properties (ASTM D149-61)
Coating Thickness 8+ mil.

STEEL BAND SPACERS & INSULATORS (MODEL SI)

Carbon steel spacers are available with a thermoplastic powder coating for extra corrosion protection. APS believes that fusion bonded coatings provide the most complete and effective corrosion protection available.

While casing spacers are available in a number of sizes, APS is also capable of manufacturing spacers for specific customer requirements. The APS engineering staff has experience with:

- Placing multiple carriers within one casing
- Positioning thermally insulated pipe without damage to insulation
- Centering small carriers within large casings
- Positioning gravity sewer to on-grade requirements
- Casing spacers for all types and sizes of pipe above 4"

Steel Band Casing Insulators are ideal for use with heavy pipe and long casing sections and are recommended for

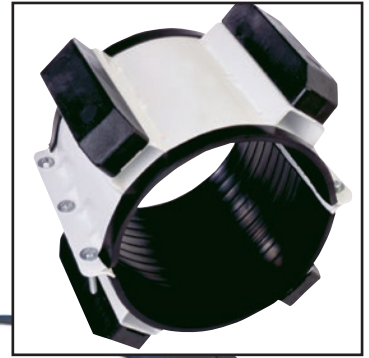

Property	Test Description	Results
Adhesion to Steel (Shear)	ASTM D 1002 10 mil (254 micron) glue line	>3000 psi >210 kg/cm ²
Adhesion to Steel (Crosshatch)	DIN 53151	GT 0-1, no lifting of coating
Impact	Gardner 5/8" (1.6 cm) diameter tup 1/8" x 3" x 3" (0.32 cm x 7.6 cm x 7.6 cm) steel panel	160 in-lbs 1.8 kg•m
Hardness	Shore D	79
Abrasion	ASTM D 1004	0.0569 g loss
Resistance	CS-10, 1000g weight, 5000 cycles	
Electric Strength	ASTM D 119	950 v/mil 37, 4 kv/mm
Gloss	Gardner 20 Degree Specular Gardner 60 Degree Specular Gardner 85 Degree Specular	20 58 78
Bendability	3/8" (9.5 mm) coupon mandrel bend at 73 °F (23 °C) at 32 °F (0 °C)	8 pipe diameters 7.2"/dia length 20 pipe diameters 2.9"/dia length
Salt Fog	ASTM B 117, 96 hours	No effect

every 6 to 8 feet of pipeline, depending on pipe type. They are available in two widths: Model SI8 (8" wide) for carrier pipes 4" to 36"; and Model SI12 (12" wide) for carrier pipes above 36" to 120" and larger. The band is constructed of 14 gauge steel coated with 8+ mils of thermoplastic powder coating, with a standard 90 mil. thick PVC liner.

FIELD-CHANGEABLE RISERS/RUNNERS FOR CASING SPACERS

APS offers Field-Changeable Risers/Runners for Casing Spacers with 8" wide bands.

Facts & Advantages:

- Field-changeable
- Used for easy grade and elevation adjustment of gravity sewer lines
- Lend the ability to stock in-house decreasing inventory up to 75%
- Stockable spacers will include 10-12 bands up to 24"
- Risers/Runners size from 1" to 6" in 1/2" increments (see pages 3 and 4 for list of all riser/runner sizes)

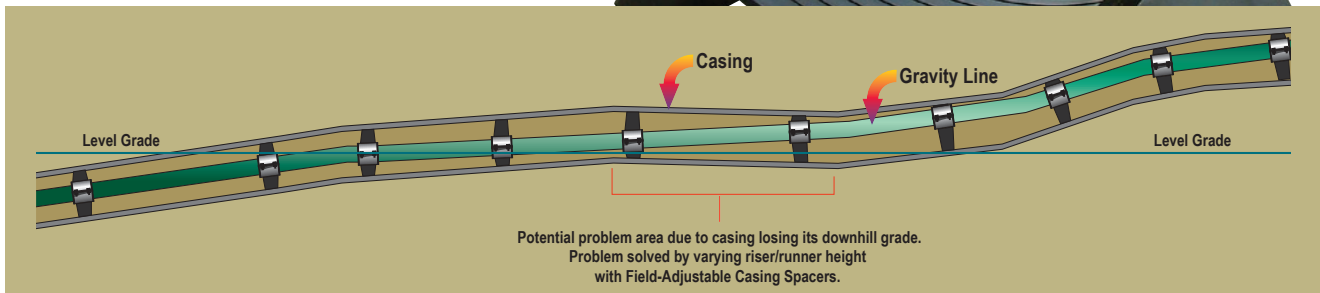
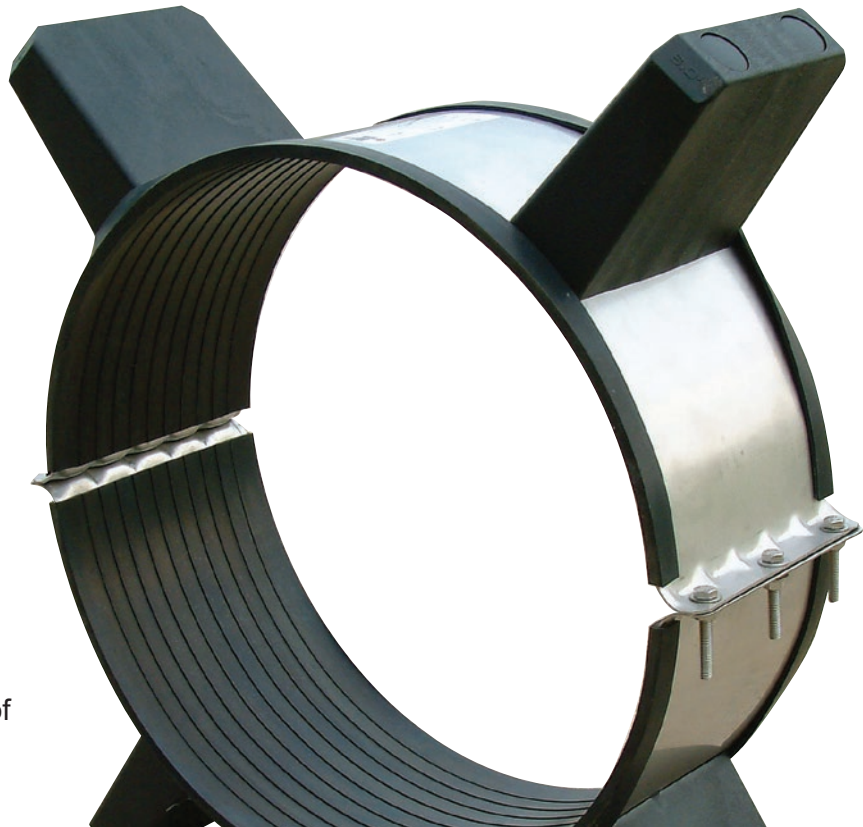

*Patented

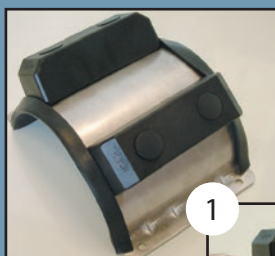

1

Changing riser/runner size for grade and elevation adjustment is quick and easy

Remove riser/runner caps



2

Unbolt old riser/runner using ordinary hand tools



3

Choose riser/runner height needed and slip on to anchor bolts

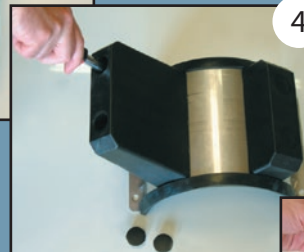

4

Rebolt and replace caps (do not exceed 80 in-lbs), casing spacer is ready for installation

5



IN-HOUSE TESTING OF FIELD-ADJUSTABLE RUNNERS FOR CASING SPACERS

VERIFIED BY A THIRD-PARTY INDEPENDENT TESTING LAB



In-house testing chamber

Runner Load X Deflection Test

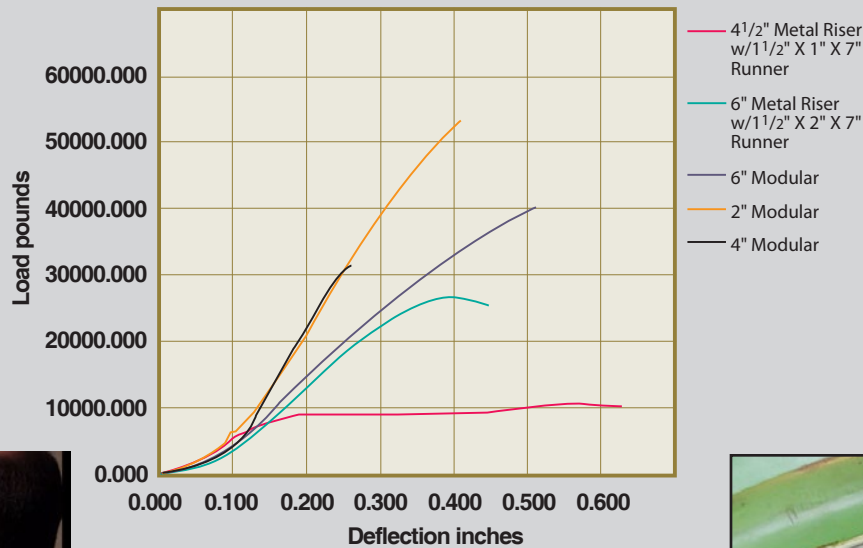
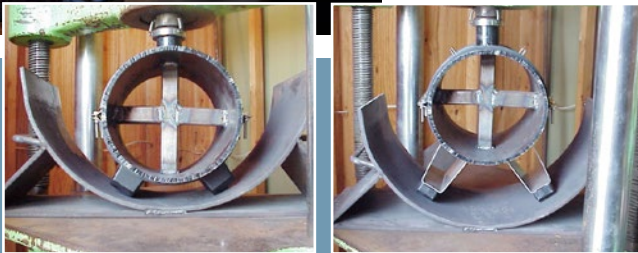
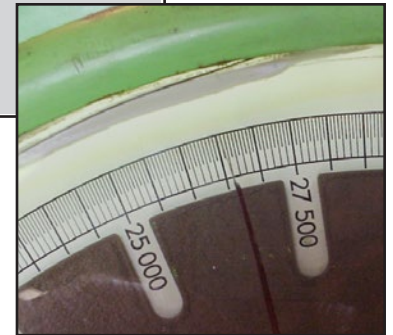

Photo representation of engineering and quality control department. AutoCAD and Solid Works drawings and computer modeling of spacer designs supplied.



THIRD-PARTY TESTING BY SCIENTIFIC TESTING LABORATORIES, INC. OF BATON ROUGE, LOUISIANA.

Design load capacities were exceeded in each of the test cases proving that APS' new Field-Adjustable Runners are not only convenient to use but also are stronger than conventional casing spacers.

Five types of runner legs were submitted for testing. Testing consisted of load tests to determine the maximum compressive load capacity of the five styles of modular runners.

The following conclusions were based upon the analysis:

1. The 4 1/2" metal riser w/1 1/2" X 1" X 7" runner sustained a maximum load of over 10,000 lbs. exceeding the design load of 4,346 lbs. by more than 2.4 times.
2. The 6" metal riser w/1 1/2" X 1" X 7" runner sustained a maximum load of over 25,000 lbs. exceeding the design load of 4,346 lbs. by more than 5.8 times.
3. The plastic 6" modular runner sustained a maximum load of over 40,000 lbs. exceeding the design load of 4,346 lbs. by more than 9.2 times.
4. The plastic 2" modular runner sustained a maximum load of over 53,000 lbs. exceeding the design load of 4,346 lbs. by more than 12.3 times.
5. The plastic 4" modular runner sustained a maximum load of over 32,000 lbs. exceeding the design load of 4,346 lbs. by more than 7.4 times.



APOGEEAERO® ANTI-CORKSCREWING ROLLER CASING SPACERS

***Patented

- REDUCED COEFFICIENT OF FRICTION
- REDUCED SIZE OF EQUIPMENT
- REDUCED INSTALLATION TIME
- REDUCED COST OF PROJECT

*** ApogeeAero® anti-corkscrew feature may not be applicable to all designs. Please consult APS for applications.

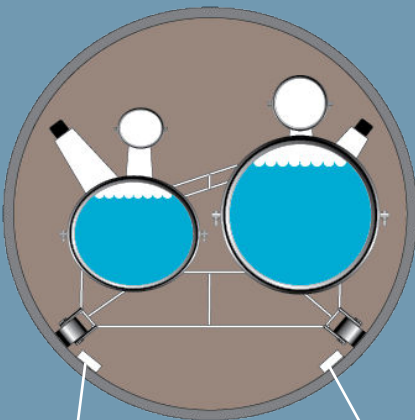
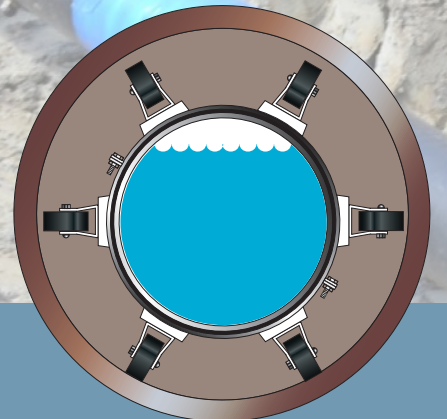
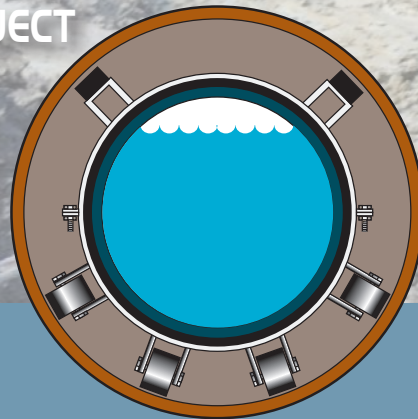
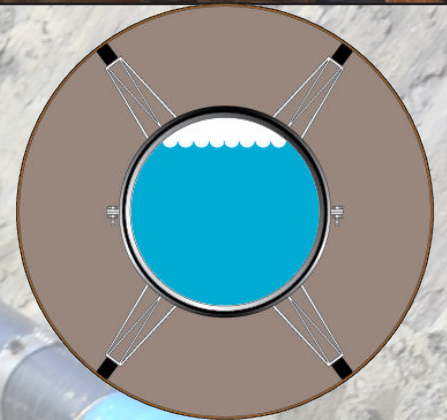

*** Flat bar guides should be provided by end user

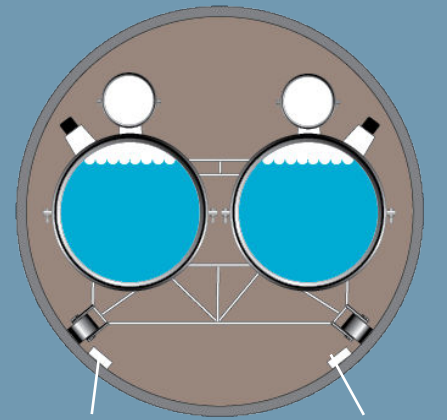
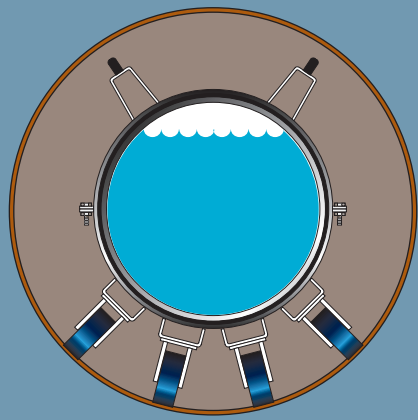

*** Flat bar guides should be provided by end user

COEFFICIENTS OF FRICTION

Material Type	Coefficient Against Steel	Coefficient Against Concrete	Coefficient Against HDPE
Liner on Carrier	0.85 μ	1.3 μ	1.00 μ
Standard Glass/Nylon	0.15 to 0.2 μ	0.4 μ	0.30 μ
UHMW	0.1 to 0.15 μ	0.3 μ	0.20 μ
HDPE	0.25 μ	0.5 μ	0.25 μ
ApogeeAero® Rollers	0.05 μ	0.06 μ	0.04 μ

APS... THE LEADER FOR CASING SPACER CLUSTERS

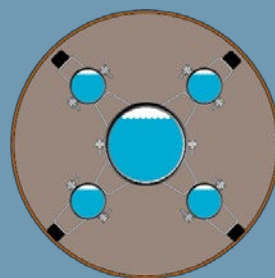
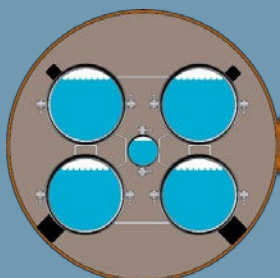
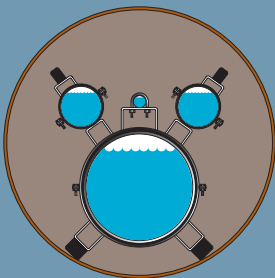
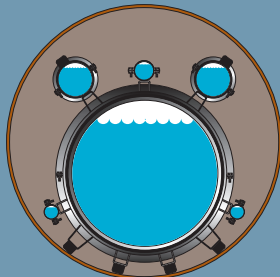
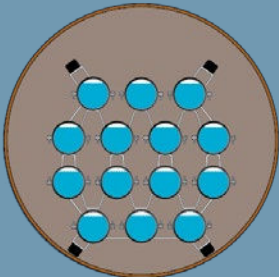
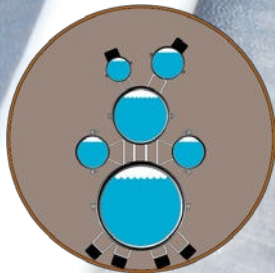
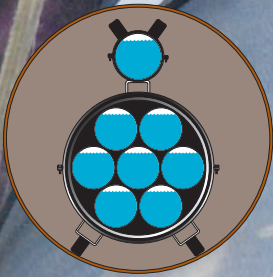

TYPES OF APS CLUSTERS:

- For Multiple Pipe Clusters
- For Conduit Pipes
- For Cables

We have supplied spacers for as many as 24 carrier pipes in one casing.



POLYETHYLENE CASING INSULATORS

Carrier Size	Min. Casing Size	Diameter Over Shoes*	Shoe Height	No. of Runners	Number Of Segments			Insulator Width
					Full 4 PI	Full 2 PI	Total Segs	
1"	3"	2 1/4"	1/2"	2	—	—	2	3"
1 1/2"	3"	2 3/4"	1/2"	4	—	—	2	3"
2"	4"	3 1/2"	5/8"	4	—	—	2	3 1/4"
3"	6"	5"	3/4"	4	—	—	2	3 1/4"
4"	6"	5 1/2"	9/16"	4	—	—	2	3 1/4"
4"	8"	6 1/4"	1"	4	—	—	2	3 1/4"
4"	10"	7 3/8"	1 1/2"	4	—	—	2	3 1/4"
4"	12"	8 3/8"	2"	4	—	—	2	3 1/4"
6"	10"	8 3/4"	1"	4	—	—	2	3 3/4"
6"	12"	9 5/8"	1 1/2"	4	—	—	2	3 3/4"
6"	14"	10 5/8"	2"	4	—	—	2	3 3/4"
8"	12"	10 3/4"	1"	4	—	—	2	4 3/4"
8"	14"	11 3/4"	1 1/2"	4	—	—	2	4 3/4"
8"	16"	12 5/8"	2"	4	—	—	2	4 3/4"
10"	14"	12 3/4"	1"	4	—	—	2	4 3/4"
10"	16"	13 3/4"	1 1/2"	4	—	—	2	4 3/4"
10"	18"	14 3/4"	2"	4	—	—	2	4 3/4"
12"	16"	14 3/4"	1"	4	—	—	2	4 3/4"
12"	18"	15 7/8"	1 1/2"	4	—	—	2	4 3/4"
12"	20"	16 3/4"	2"	4	—	—	2	4 3/4"
14"	18"	15 7/8"	1"	7	3	1	4	6"
16"	20"	17 7/8"	1"	8	4	—	4	6"
18"	22"	19 7/8"	1"	9	4	1	5	6"
20"	24"	21 7/8"	1"	10	5	—	5	6"
22"	26"	23 7/8"	1"	11	5	1	6	6"
24"	28"	25 7/8"	1"	12	6	—	6	6"
26"	30"	27 7/8"	1"	13	6	1	7	6"
28"	32"	29 7/8"	1"	14	7	—	7	6"
30"	34"	31 7/8"	1"	15	7	1	8	6"
32"	36"	33 7/8"	1"	16	8	—	8	6"
34"	38"	35 7/8"	1"	17	8	1	9	6"
36"	40"	37 7/8"	1"	18	9	—	9	6"
38"	42"	39 7/8"	1"	19	9	1	10	6"
40"	44"	41 7/8"	1"	20	10	—	10	6"
42"	46"	43 7/8"	1"	21	10	1	11	6"
44"	48"	45 7/8"	1"	22	11	—	11	6"
46"	50"	47 7/8"	1"	23	11	1	12	6"
48"	52"	49 7/8"	1"	24	12	—	12	6"
50"	54"	51 7/8"	1"	25	12	1	13	6"
52"	56"	53 7/8"	1"	26	13	—	13	6"
54"	58"	55 7/8"	1"	27	13	1	14	6"
56"	60"	57 7/8"	1"	28	14	—	14	6"
60"	64"	61 7/8"	1"	30	15	—	15	6"

POLYETHYLENE CASING INSULATORS	
Dielectric Strength (ASTM D-149)	450-500 Volts/Mil
Flexural Strength (ASTM D-790)	4600 psi
Compressive Strength (ASTM D-695)	4600 psi
Tensile Strength (ASTM D-638)	4600 psi
Water Absorption (ASTM D-570)	< 0.01%
Impact Strength (ASTM D-256)	1.3 ft. lb/in.
Maximum Continuous Operating Temperature	-72°F - 180°F (-57°C - 82°C)



* Runners 1-1/2" and 2" high are available on 4" and above Polyethylene casing Insulators
 NOTE: Centered or centered and restrained polyethylene insulators are also available on PVC pipe through 24".



POLYETHYLENE SPACERS & INSULATORS (MODEL CI)

With excellent dielectric resistance and low moisture absorption for minimal electric current loss and no impairment of cathodic protection, polyethylene spacers and insulators are an economical choice for use on all plastic pipe, metal pipe up to 60" in diameter and smaller ductile pipe.

Polyethylene casing spacers and insulators are manufactured by injection molding using polyethylene, which provides high impact strength and a low coefficient of friction.

Two halves are used to construct the 1" through 12" spacers while 14" and above are multi-segmented. Runner height for polyethylene spacers can be increased to provide clearance for bell and spigot connections. Ideal

for most sizes of schedule 40 and schedule 80 PVC, C 900, SDR 21 & 26, Ultra-Rib and more, they are only recommended for use on 12" and smaller ductile iron pipe.

Polyethylene casing insulators are recommended for every 5 feet of pipeline. Molded into the inner surface of the casing insulators are grooves which prevent slippage of any carrier pipe coating. Lightweight, economical and easy to install, APS Polyethylene Casing Insulators require only a screwdriver for installation. Do not exceed 35 in-lbs of torque.

Sizes are available from 1" through 60" with a standard runner height of 1". Casing Insulators from 1" through 12" are constructed of two halves, 2 PI and 4 PI sections make up 14" and above.

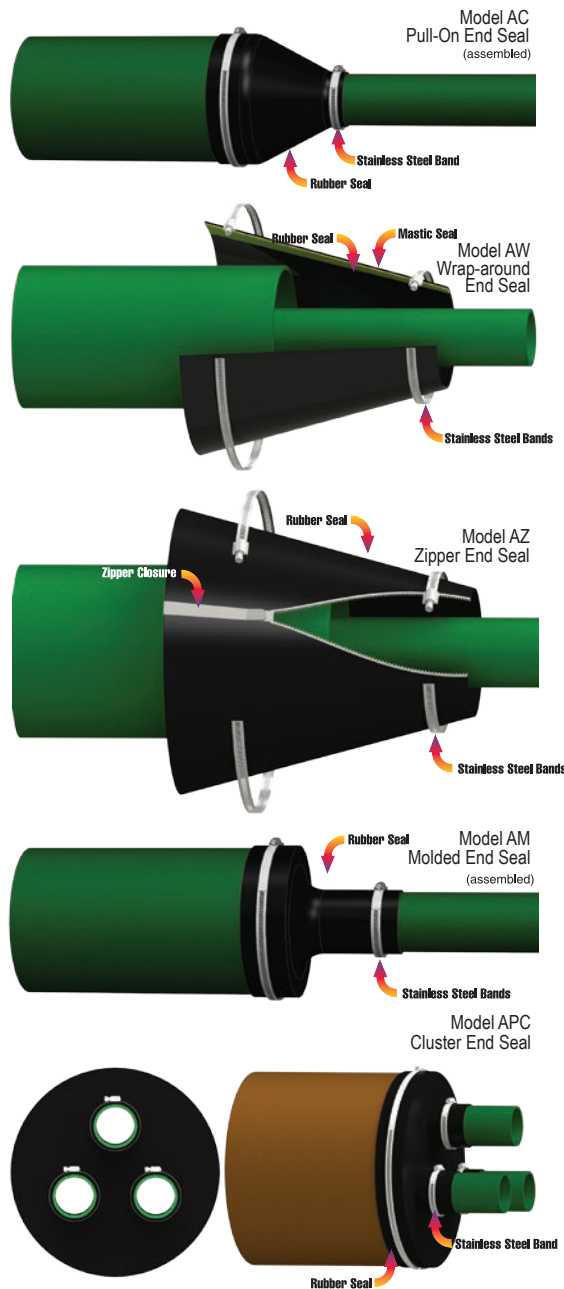

Innerlynx Model End Seal

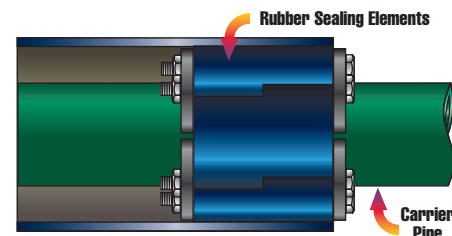

TYPES OF INNERLYNX END SEALS

IL-C - Standard pipe Innerlynx® with insulating type plate.

IL-S316 - Pipe Innerlynx® with stainless steel hardware.

IL-CB - Pipe Innerlynx® with centering block feature.*

IL-O Nitrile - Innerlynx® can be used for fuel applications in airports

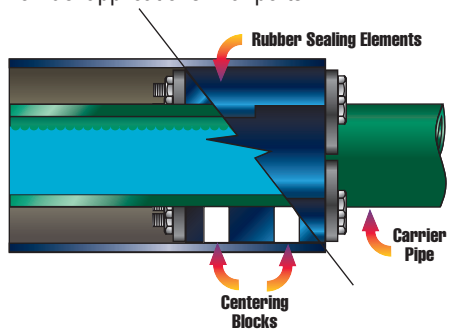
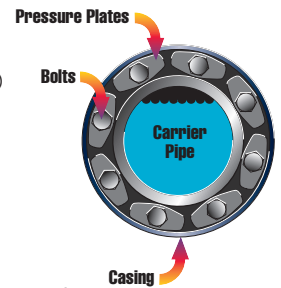

*Centering Blocks are plastic reinforcements that assure a penetrating pipe will stay "centered" within its casing and adds extra support against heavy loads from back fill.

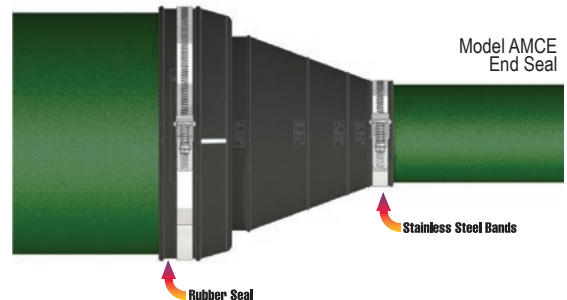

APS manufactures full conical shaped end seals in the seamless pull-on, wrap-around, molded, zipper and cluster styles. All five are made of 1/8" thick synthetic rubber assuring excellent chemical resistance and resiliency and can accommodate any combination of pipe sizes. APS offers end seals in various materials such as silicone, neoprene, and EPDM. These products outperform the costly and labor intensive brick and mortar method of sealing casing ends. While soil stress and pipe movement cause mortar to crack, the APS end seals move with the pipe insuring the integrity of your seal.

The model AC and AM end seals can easily be installed at the time of construction. Models AC, AW and AZ can be produced in concentric (for centered carrier pipes) and eccentric (for non-centered pipes). The model AW wrap-around end seals are designed to facilitate installation when the carrier line has already been installed and the pull is complete. Simply wrap around the carrier and casing, remove the release liner from the two pressure sensitive butyl mastic strips and press the adhesive strips down to

form a seal.

Model AZ, zipper type end seal, is designed for use on new construction and on existing casings that require modifications or extension. Stainless steel zippers are pressure molded to the rubber and feature a protective rubber strip attached to the seal under the zipper to prevent damage or abrasion to the pipe. They are also easy to install. The seal wraps around the casing end and carrier pipe and zips shut to provide a tight seal while still allowing for pipe movement.

Model APC, cluster end seals, are now available for multi-carrier installations. Contact customer service for more information.

All five types of APS End Seals are secured with stainless steel banding straps with a 100% non-magnetic worm gear mechanism to insure the integrity of the clamp. Only a screwdriver is needed for installation.

In addition, Innerlynx form a mechanical seal between pipelines and casing. Innerlynx form a hydrostatic seal and electrically isolate the carrier pipe from the casing. Innerlynx can be installed by one person and require no special tools.

ORDER INSTRUCTIONS

Please Indicate The Following:

- Project Reference and Location

Metal Insulators

- Model number: SI (steel) or SSI (stainless steel)
- Carrier Pipe O.D. Including Coating Thickness
- O.D. of Bell or Mechanical Joint
- Casing O.D.
- Casing Wall Thickness
- Type or Size of Runner
- Height and Width of Runner
- Configuration: Clear Bell, Centered, Centered and Restrained, or Non-centered and Restrained

Plastic Insulators

- Carrier Pipe O.D. Including Coating Thickness
- O.D. of Bell or Mechanical Joint
- Casing O.D.
- Casing Wall Thickness
- Configuration: Clear Bell, Centered, Centered and Restrained, or Non-centered and Restrained

End Seals

- Model: AC (pull-on), AW (wrap-around), AZ (zipper), AM (molded)
- Carrier Pipe O.D. Including Coating Thickness
- Casing O.D.
- Configuration: Centered or Non-centered

OTHER PRODUCTS AVAILABLE

- Integra® Series Gaskets
- Kleerband® Flange Band Protectors
- Kleergel® Corrosion Inhibiting Grease
- Radolid® Nut & Bolt Protection Caps
- ApogeeAero® Roller Casing Spacers
- Bore & Duct Bank Spacers
- Innerlynx® Modular Mechanical Seals
- Wall Sleeves
- Foreman Nite Caps
- UBolt-Cote® & Atlas Pipe Support® Pads
- IsoJoint® Monolithic Isolating Joints
- Safety Spray Shields



PO Box 60399

Lafayette, Louisiana 70596-0399

800-315-6009 • 337-233-6116 • Fax 337-232-3860

E-Mail: sales@apsonline.com • Website: www.apsonline.com



Distributed by:

Advance Products & Systems, LLC is not responsible for errors printed in this brochure.

Advance Products & Systems, LLC shall repair or replace (within the limitations of such applicable express written warranty as may be issued by it) any product or portions thereof, which prove to be defective in workmanship or material for a period of 12 months from shipment date. The foregoing in lieu of all warranties, express or implied, and all other obligations or liabilities on the part of APS, on account of the product which it may sell. In no event shall APS be liable for consequential or special damages: nor except as it may otherwise specifically agree in writing, installation, or other work which may be done upon or in connection with the product by APS/ the distribution / dealer or others. THE LIMITED WARRANTIES PROVIDED IN THIS AGREEMENT AND THE OBLIGATIONS AND LIABILITIES OF APS ARE THE ONLY WARRANTIES MADE BY APS AS TO THE PRODUCT. APS MAKES NO EXPRESS OR OTHER IMPLIED WARRANTIES, BY COURSE OF DEALING, USAGE OF TRADE, MERCHANTABILITY, FITNESS FOR A PARTICULAR USE (WHETHER GENERAL OR SPECIFIC), OR OTHERWISE.

REV 080323